

GERDA®

EUROPEAN SECURITY DOOR MANUFACTURER

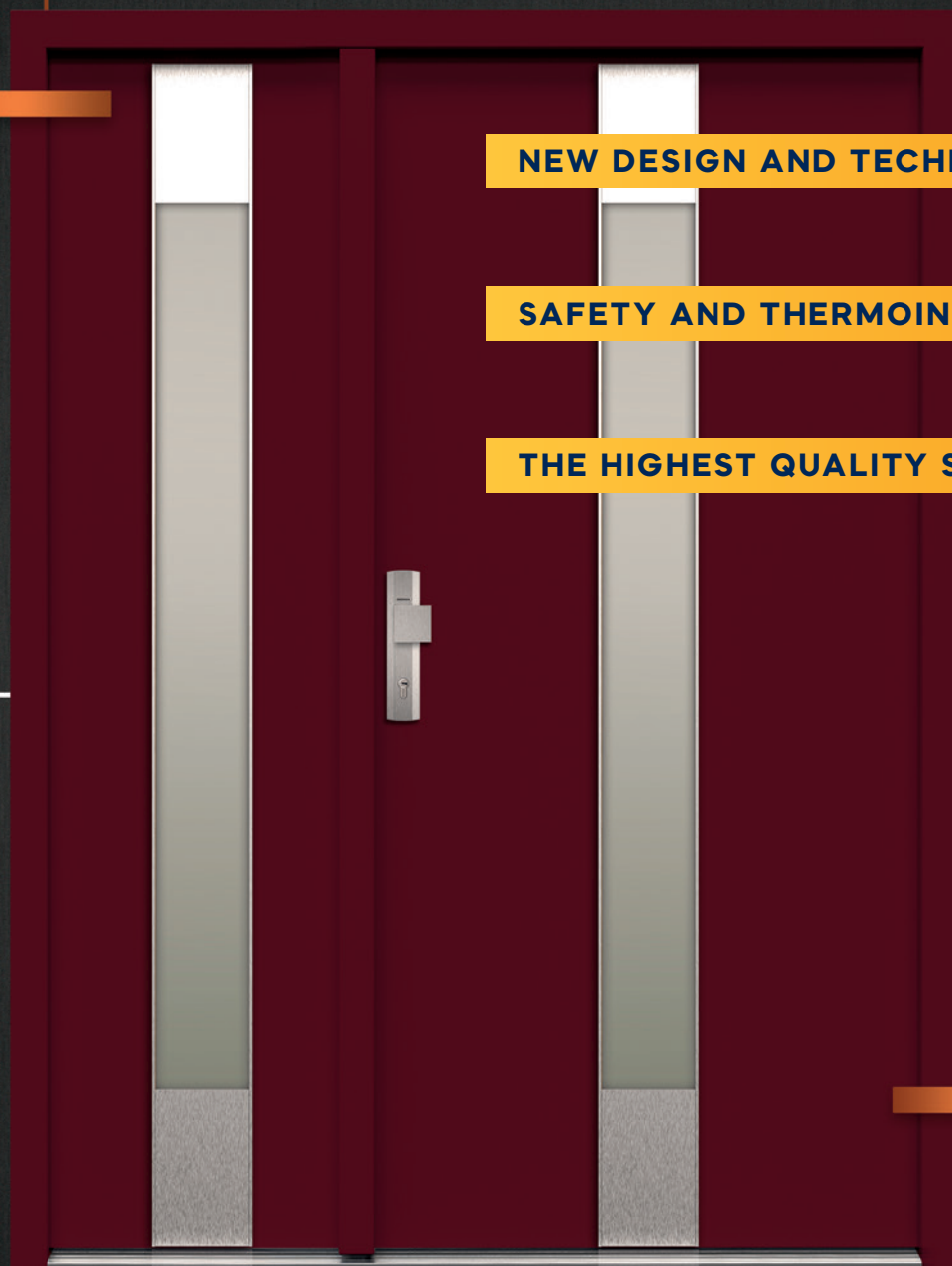

NEW DESIGN AND TECHNOLOGIES

SAFETY AND THERMOINSULATION

THE HIGHEST QUALITY STANDARDS

THERMO PRIME
THERMO PREMIUM
THERMO PREMIUM DUO



ENTRY DOORS TORONTO INC.

Quality is not an act, it is a habit!

EDITION 1.2025

tedee PRO

powered by **GERDA**[®]

TURN YOUR SMARTPHONE INTO A SMART DOOR LOCK



OPEN DOORS WITH YOUR SMARTPHONE

Open and close doors and monitor door lock status from any place around the world. With the automatic opening feature, you don't need to take your phone out from your purse or pocket. The lock will detect your presence and let you in. The self-locking feature works based on the same principle.

SET

tedee PRO SMARTLOCK + tedee BRIDGE + CLASS 6 LOCK CYLINDER

HIGH-PERFORMANCE BATTERY

Gerda engineers, in collaboration with the South Korean Research Institute, have developed a small dedicated high-performance battery. It powers the mechanism for six months of operation. And when in need of recharging, the lock will let you know as you can charge the battery overnight.

SAFETY WARRANTY

The lock actuating mechanism is an innovative, patented design developed by Gerda engineers. The software was created by Tedee IoT experts. An intuitive app lets you keep track of who and when has locked or unlocked the door. It also offers a virtual key allocation feature.



CLASS 6 LOCK CYLINDERS INCLUDED

ANTI-BURGLARY TUMBLER LOCK INSERT. NEW LOCK INSERT DESIGN SECURED AGAINST 'LOCK BUMPING', WITH EFFECTIVE DRILL OPENING PROTECTION.



INSTALL A TEDEE LOCK

SLIDE THE LOCK ONTO A GERDA INSERT, ADJUST THE LOCK POSITION AND SECURE IT WITH ONE BOLT. INSTALLATION TAKES NO MORE THAN TWO MINUTES. INSPECT TO SEE WHETHER THE BOLTS SLIDE UPON TURNING THE KNOB.



INSTALL THE SMARTPHONE APP

DOWNLOAD THE **tedee** APP FROM APPLE STORE OR GOOGLE PLAY. SIGN UP AND ACTIVATE YOUR BLUE-TOOTH, LOCATION SERVICE AND INTERNET ACCESS. ADD YOUR LOCK AND ENTER THE ACTIVATION CODE.







CONNECT THE BRIDGE

FIND A FREE POWER SOCKET NEXT TO THE **tedee** LOCK AND PLUG THE BRIDGE IN. THIS WILL ENABLE YOU TO CONTROL THE LOCK OVER THE INTERNET FROM WHEREVER YOU ARE.



 **THERMO PRIME 75**

UD	THERMAL INSULATION U _v VALUES FOR INWARD-OPENING REFERENCE DOORS	ALUTHERM 75 DOOR FRAME SOLID DOOR 0,79 W/m²K GLAZED DOOR 0,9 W/m²K
RC	RESISTANCE CLASS	RC2
	LEAF THICKNESS	75 mm
	DOOR SIZES	80 · 90N · 90E · 100E*
	DESIGN LINES	CROSS LINE · AIR GLASS · QUADRO · ELITE 3D · TEMPO
	LEAF STRUCTURE	WOODEN FRAME + PUR FOAM
	DOOR TO SIZE	DOOR HEIGHT UP TO 2400 mm DOOR WIDTH UP TO 1130 mm

**ALUTHERM 75 DOOR FRAME
SOLID DOOR / GLAZED DOOR**

$U_d = 0,79 / 0,9 \text{ W/m}^2\text{K}$

**STEEL DOOR FRAME
SOLID DOOR / GLAZED DOOR**

-

RC2

SET (DOOR LEAF, THRESHOLD, DOOR FRAME, HARDWARE WITH CLASS 5 LOCK CYLINDER, MOUNTING KIT)



Adjustable hook hitches



Adjustable pawl hitch



Hinges adjustable in three planes with caps matching hardware's colour



Door leaf with thermal division

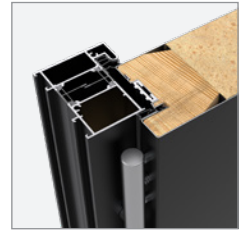

ALUTHERM 75 door frame



Mortise lock: 5 point hooked or 3 point automatic

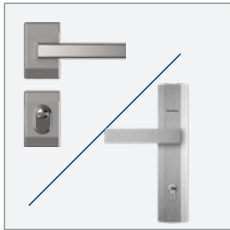

You can choose NEW long door plate PRAGA or split door plate BERGEN



Ring escutcheon for door with a handrail*



Composite connector of threshold with windstopper

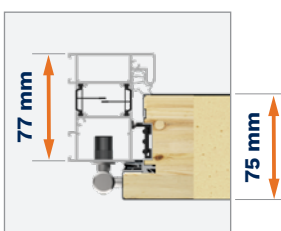

ALUTHERM 75 door frame



4 sides rebated



Class 5 lock cylinder, AB system: A – installer's keys + B – final user keys



Lower upstand brush seal PRIME



Fixed anti-prizing bolts

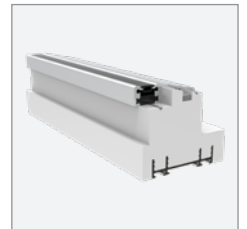

Warm aluminium with subthreshold extension, h=35 mm



GERDA RESIST ULTRA insulation duo tapes*







tedee PRO + bridge set*

* EXTRA CHARGE



 **THERMO PREMIUM 75**

UD	THERMAL INSULATION U _f VALUES FOR INWARD-OPENING REFERENCE DOORS	ALUTHERM 75 DOOR FRAME* SOLID DOOR 0,79 W/m²K GLAZED DOOR 0,85 W/m²K	DUOTHERM 75 DOOR FRAME SOLID DOOR 0,87 W/m²K GLAZED DOOR 0,98 W/m²K
RC	RESISTANCE CLASS	RC2 / RC3**	
	LEAF THICKNESS	75 mm	
	DOOR SIZES	80 · 90N · 90E · 100E*	
	DESIGN LINES	CROSS LINE · AIR GLASS · QUADRO · ELITE 3D · TEMPO	
	LEAF STRUCTURE	WOODEN FRAME + EXPANDED GRAPHITE POLYSTYRENE	
	DOOR TO SIZE	DOOR HEIGHT UP TO 2400 mm DOOR WIDTH UP TO 1130 mm	

**ALUTHERM 75* DOOR FRAME
SOLID DOOR / GLAZED DOOR**

**DUOTHERM 75 DOOR FRAME
SOLID DOOR / GLAZED DOOR**

$U_D = 0,79 / 0,85 \text{ W/m}^2\text{K}$

$U_D = 0,87 / 0,98 \text{ W/m}^2\text{K}$

RC2 / RC3**

SET (DOOR LEAF, THRESHOLD, DOOR FRAME, HARDWARE WITH CLASS 5 LOCK CYLINDER, MOUNTING KIT)

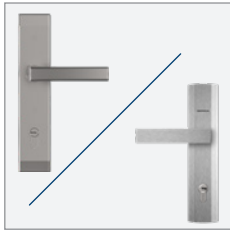

You can choose NEW long door plate PRAGA or split door plate BERGEN



Class 5 lock cylinder, AB system: A – installer's keys + B – final user keys

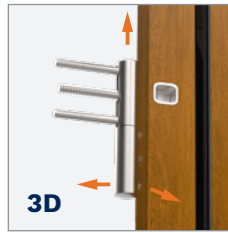

Hinges adjustable in three planes with caps matching hardware's colour

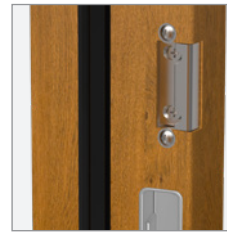

Adjustable pawl hitch

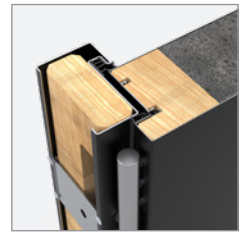

DUOTHERM 75 door frame



Auxiliary 3-bolt lock



Main 3-bolt lock



Mortise lock 3-point 2-hook

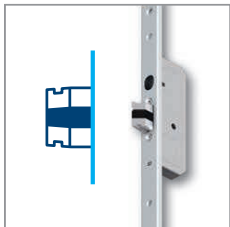

Mortise lock 3-point automatic

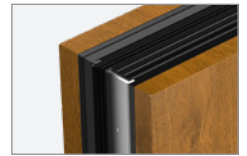

Door leaf with thermal division



Lower upstand brush seal



Fixed anti-prizing bolts

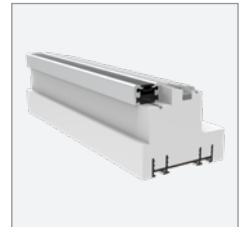

Warm aluminium with subthreshold extension, h=35 mm



GERDA RESIST ULTRA insulation duo tapes*

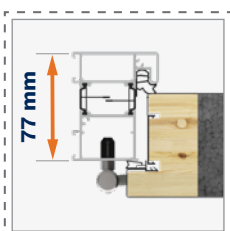

ALUTHERM 75* door frame

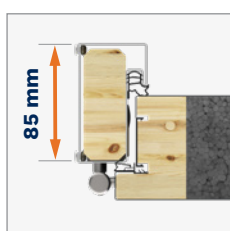

DUOTHERM 75 door frame



Composite connector of threshold with windstopper



4 sides rebated









tedee PRO + bridge set*

* EXTRA CHARGE

** FOR SOLID DOORS ONLY, EXTRA CHARGE



 **THERMO PREMIUM 75 DUO**

UD	THERMAL INSULATION U _D VALUES FOR INWARD-OPENING REFERENCE DOORS	ALUTHERM 75 DOOR FRAME SOLID DOOR (BOTH LEAVES) 0,8 W/m²K GAZED DOOR (BOTH LEAVES) 0,9 W/m²K
RC	RESISTANCE CLASS	RC2**
	LEAF THICKNESS	75 mm
	DOOR SIZES	80 · 90N · 90E · 100E*
	PASSIVE DOOR SIZES	30 · 40 · 50
	DESIGN LINES	CROSS LINE · AIR GLASS · QUADRO · ELITE 3D · TEMPO
	LEAF STRUCTURE	WOODEN FRAME + EXPANDED GRAPHITE POLYSTYRENE
	DOOR TO SIZE	DOORS WITH MORTISE LOCK HEIGHT UP TO 2400 mm DOORS WITH BOLT LOCK HEIGHT UP TO DO 2087 mm

**ALUTHERM 75 DOOR FRAME
SOLID DOOR / GLAZED DOOR**

**STEEL DOOR FRAME
SOLID DOOR / GLAZED DOOR**

$U_d = 0,8 / 0,9 \text{ W/m}^2\text{K}$

-

RC2**

SET (DOOR LEAF, THRESHOLD, DOOR FRAME, HARDWARE WITH CLASS 5 LOCK CYLINDER, MOUNTING KIT)



Adjustable hook hitches



Adjustable pawl hitch in passive door leaf

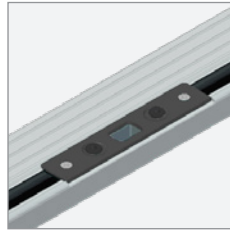

Adjustable passive door leaf catch in the threshold



Central flush bolt in the passive door leaf

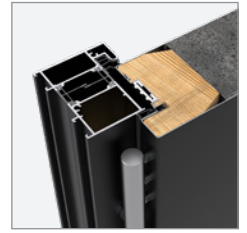

ALUTHERM 75 door frame



Auxiliary 3-bolt lock

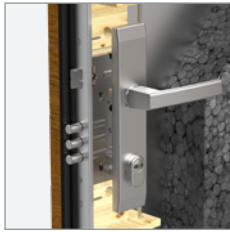

Main 3-bolt lock



Mortise lock
3-point 2-hook



Mortise lock
3-point automatic

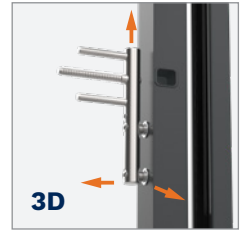

Hinges adjustable in three planes with caps matching hardware's colour



Lower upstand brush seal PRIME



Fixed anti-prizing bolts

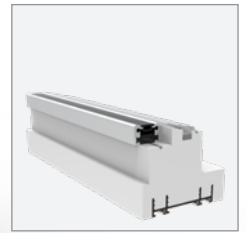

Warm aluminium with subthreshold extension, h=35 mm

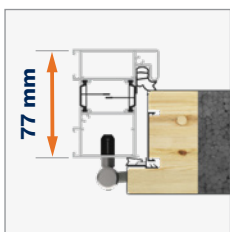

ALUTHERM 75 door frame

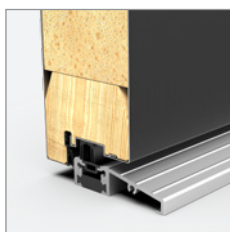

4 sides rebated in both door leaves



Class 5 lock cylinder, AB system: A - installer's keys + B - final user keys



GERDA RESIST ULTRA insulation duo tapes*





tedee PRO + bridge set**

* EXTRA CHARGE

** DOORS WITH MORTISE LOCK



THERMO PREMIUM 60

UD	THERMAL INSULATION U _f VALUES FOR INWARD-OPENING REFERENCE DOORS	ALUTHERM 60 DOOR FRAME* SOLID DOOR 0,86 W/m²K GLAZED DOOR 0,95 W/m²K	DUOTHERM 60 DOOR FRAME SOLID DOOR 0,94 W/m²K GLAZED DOOR 1,1 W/m²K
RC	RESISTANCE CLASS	RC2 / RC3**	
 mm	LEAF THICKNESS	60 mm	
	DOOR SIZES	80 · 90N · 90E · 100E*	
	DESIGN LINES	CROSS LINE · AIR GLASS · QUADRO · ELITE 3D · TEMPO	
	LEAF STRUCTURE	WOODEN FRAME + EXPANDED GRAPHITE POLYSTYRENE	
 mm	DOOR TO SIZE	DOOR HEIGHT UP TO 2400 mm DOOR WIDTH UP TO 1130 mm	

ALUTHERM 60 DOOR FRAME*
SOLID DOOR / GLAZED DOOR

DUOTHERM 60 DOOR FRAME
SOLID DOOR / GLAZED DOOR

$U_D = 0,86 / 0,95 \text{ W/m}^2\text{K}$

$U_D = 0,94 / 1,1 \text{ W/m}^2\text{K}$

RC2 / RC3**

SET (DOOR LEAF, THRESHOLD, DOOR FRAME, HARDWARE WITH CLASS 5 LOCK CYLINDER, MOUNTING KIT)

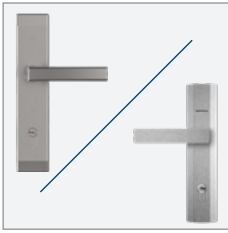

You can choose NEW long door plate PRAGA or BERGEN

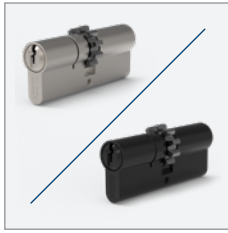

Class 5 lock cylinder, AB system: A – installer's keys + B – final user keys

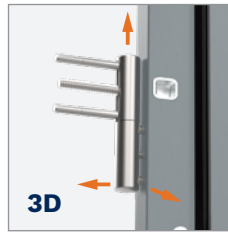

Hinges adjustable in three planes with caps matching hardware's colour



Adjustable pawl hitch

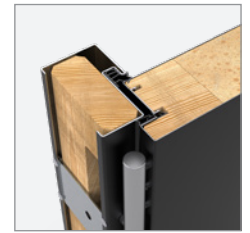

DUOTHERM 60 door frame



Auxiliary 3-bolt lock

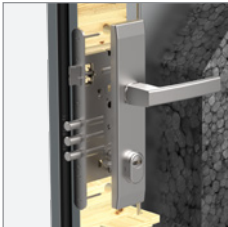

Main 3-bolt lock



Mortise lock 3-point 2-hook

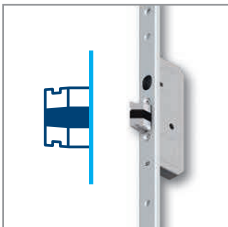

Mortise lock 3-point automatic

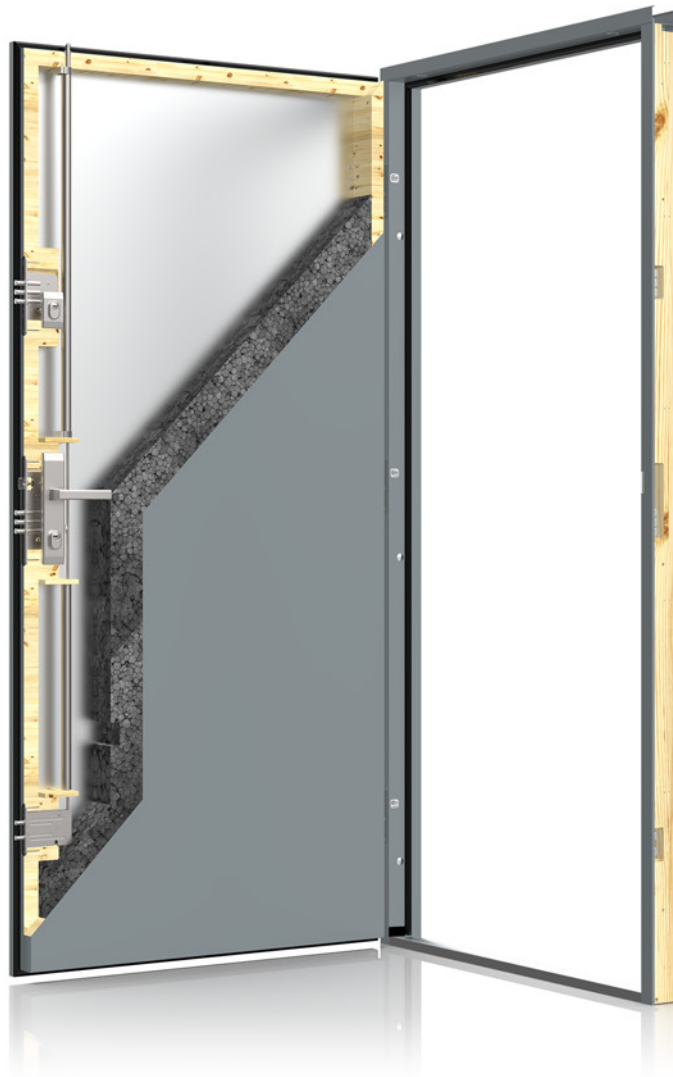

Lower upstand brush seal



Fixed anti-prizing bolts



Warm aluminium with subthreshold extension, h=35 mm



GERDA RESIST ULTRA insulation duo tapes*

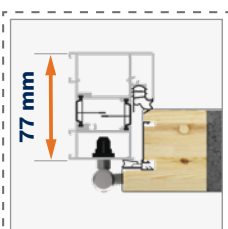

ALUTHERM 60* door frame

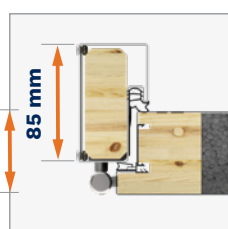

DUOTHERM 60 door frame



Composite connector of threshold with windstopper



4 sides rebated



tedee PRO + bridge set*

* EXTRA CHARGE

** FOR SOLID DOORS ONLY, EXTRA CHARGE

CROSS LINE

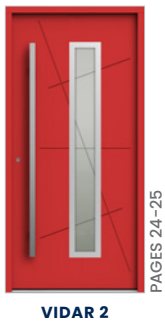
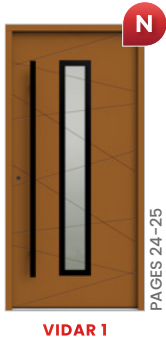

CROSS LINE
DUO

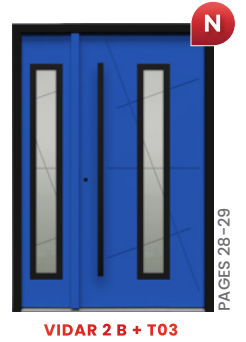

AIR GLASS

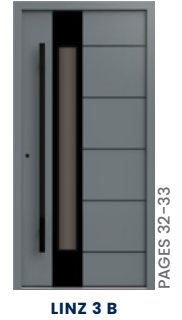

AIR GLASS



AIR GLASS
DUO

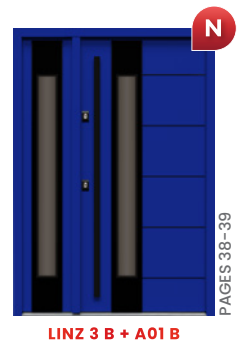
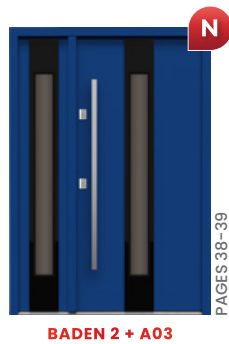
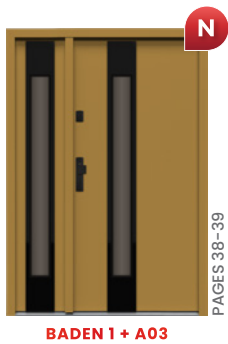

QUADRO

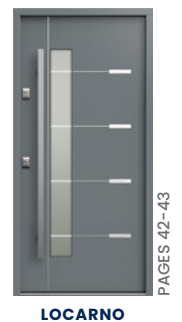
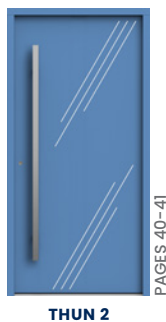

QUADRO



ONEX

PAGES 42-43



PASAWA 1

PAGES 44-45



PASAWA 3

PAGES 44-45



PASAWA 4

PAGES 44-45



JENA 3

PAGES 46-47



JENA 4

PAGES 46-47



JENA 5

PAGES 46-47

QUADRO



BAMBERG 1

PAGES 48-49



BAMBERG 2

PAGES 48-49



BAMBERG 3

PAGES 48-49



BAMBERG 4

PAGES 48-49



ULM 1

PAGES 50-51



ULM 2

PAGES 50-51



TREWIR 1

PAGES 52-53

QUADRO



TREWIR 2

PAGES 52-53



TREWIR 3

PAGES 52-53



TREWIR 4

PAGES 52-53



KRONACH 1

PAGES 54-55



KRONACH 2 B

PAGES 54-55



KRONACH 4

PAGES 54-55



REGEN 1

PAGES 56-57

QUADRO



REGEN 2

PAGES 56-57



REGEN 4

PAGES 56-57



REGEN 5

PAGES 56-57

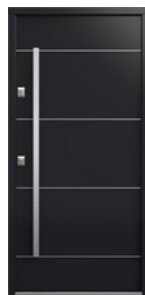

DREZNO 1

PAGES 58-59



DREZNO 4

PAGES 58-59



ERFURT 1 B

PAGES 58-59



ERFURT 2

PAGES 58-59

QUADRO
DUO



TREWIR 1 B + Q05 B

PAGES 62-63



JENA 3 + Q02

PAGES 60-61



REGEN 5 + Q08

PAGES 62-63



KRONACH 4 + Q12

PAGES 64-65

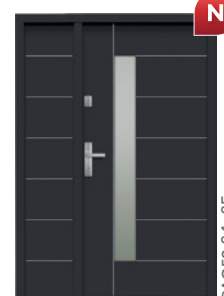

PASAWA 3 + Q11

PAGES 64-65

TEMPO



MILANO 8

PAGES 70-71



MILANO 9

PAGES 70-71



MILANO 10

PAGES 70-71



MILANO 11

PAGES 70-71



MILANO 12 B

PAGES 70-71



HANOVER 5

PAGES 72-73



HANOVER 6

PAGES 72-73

TEMPO



INNSBRUCK

PAGES 72-73



PLAIN

PAGES 74-75



MILANO 4

PAGES 76-77



MILANO 4 A

PAGES 76-77

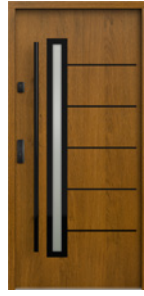

MILANO 4 B

PAGES 76-77



TURYN 1

PAGES 78-79



TURYN 1 B

PAGES 78-79

TEMPO



BERGAMO 2

PAGES 80-81



NICEA 9

PAGES 80-81



UPPSALA 1

PAGES 82-83

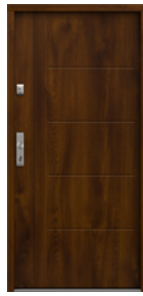

UPPSALA 1

PAGES 82-83



UPPSALA 1A

PAGES 82-83



TOKIO 1

PAGES 84-85



TOKIO 1 A

PAGES 84-85

TEMPO



TOKIO 2

PAGES 84-85



TOKIO 2 A

PAGES 84-85



ASPEN 1

PAGES 84-85



ASPEN 2 B

PAGES 84-85



TROMSO

PAGES 86-87

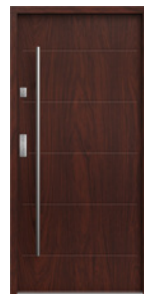

TROMSO 1

PAGES 86-87



TROMSO 2

PAGES 86-87

TEMPO DUO



MILANO 11 B + T01 B

PAGES 88-89



MILANO 8 + T02

PAGES 88-89



HANOVER 5 B + T03 B

PAGES 88-89



HANOVER 6 + T04

PAGES 88-89



BAMBERG 2 B + T05

PAGES 90-91

ELITE 3D



DAVOS

PAGES 66-67



BRIG

PAGES 66-67



OLTEN

PAGES 66-67



VISP

PAGES 66-67



TRIN

PAGES 66-67



BERNO

PAGES 66-67

ELITE 3D DUO



DAVOS + E01

PAGES 68-69



BRIG + E02

PAGES 68-69



OLTEN + E03

PAGES 68-69



VISP + E04

PAGES 68-69



TRIN + E05

PAGES 68-69

RESISTANCE TO BURGLARY

This parameter is decisive for the so-called anti-burglary doors. anti-prizing bolts that prevent forcing the door leaf or lifting it off. Such doors have a solid structure that significantly impedes the the hinges. GERDA doors are tested for resistance to burglary and possibility to cut out an opening through the door, preventing un- hold an anti-burglary protection class from RC2 to RC3. The higher authorized entrance. As a standard, GERDA doors are fitted with two the class of doors installed, the greater the safety of people and robust locks with a multi-point bolting system. Their key element are property in the house.

RC2 CLASS



PLIERS



WEDGE



HAMMER

RC3 CLASS



STEEL PRY BAR



WEDGE



HAMMER



MECHANICAL DRILL

RC4 CLASS



HEAVY HAMMER



AXE



CHISEL



BIT



HAMMER DRILL



SET GL



SET G



SET GP



SET LGP

SIDE GLAZED PANELS*

HEIGHT Hz	GLAZED PANEL / GLASS TYPE	WIDTH Ld/Pd						
		up to 300 mm	up to 400 mm	up to 500 mm	up to 600 mm	up to 700 mm	up to 800 mm	up to 900 mm
2087 mm	PANEL WITH SAFETY GLASS	✓	✓	✓	✓	✓	✓	✓
	ANTI-BULGLARY RC2 PANEL WITH P4 GLASS	✓	✓	✓	✓	✓	✓	✓
do 2200 mm	PANEL WITH SAFETY GLASS	✓	✓	✓	✓	✓	✓	✓
	ANTI-BULGLARY RC2 PANEL WITH P4 GLASS	✓	✓	✓	✓	✓	✓	✓
do 2300 mm	PANEL WITH SAFETY GLASS	✓	✓	✓	✓	✓	✓	✓
	ANTI-BULGLARY RC2 PANEL WITH P4 GLASS	✓	✓	✓	✓	✓	✓	✓
do 2400 mm	PANEL WITH SAFETY GLASS	✓	✓	✓	✓	✓	✓	✓
	ANTI-BULGLARY RC2 PANEL WITH P4 GLASS	✓	✓	✓	✓	✓	✓	✓

SIDE GLAZED PANEL STANDARD WIDTH IN 50 MM INCREMENTS. FOR 10 MM INCREMENTS – EXTRA CHARGE +25%

TOP GLAZED PANELS*

HEIGHT Hd	GLAZED PANEL / GLASS TYPE	WIDTH Ld+Sm+Pd				
		up to 1150 mm	up to 1550 mm	up to 1950 mm	up to 2350 mm	up to 2950 mm
300 mm	PANEL WITH SAFETY GLASS	✓	✓	✓	✓	✓
400 mm		✓	✓	✓	✓	✓
500 mm		✓	✓	✓	✓	✓
300 mm	ANTI-BULGLARY RC2 PANEL WITH P4 GLASS	✓	✓	✓	✓	✓
400 mm		✓	✓	✓	✓	✓
500 mm		✓	✓	✓	✓	✓

TOP GLAZED PANEL STANDARD WIDTH IN 50 MM INCREMENTS. FOR 10 MM INCREMENTS – EXTRA CHARGE +25%

ALUTHERM DOOR FRAME

SIZE	HEIGHT Hz	WIDTH Sc
80	standard 2087 mm not standard:	918 mm
90N	2150 mm	988 mm
	2200 mm	
90E	2250 mm	1031 mm
	2300 mm	
100E	2350 mm	1131 mm
	2400 mm	

FOR DOORS WITH INTEGRATED CLOSER DOOR FRAME TOTAL HEIGHT +3,5 mm.

POWDER COATING*

	SIDE/ TOP GLAZED PANEL
GALA PALETTE	✓
GALACTICA PALETTE	✓
INTERGALACTICA PALETTE	✓
GALA OPEN PALETTE	✓



SET L



SET P



SET LP

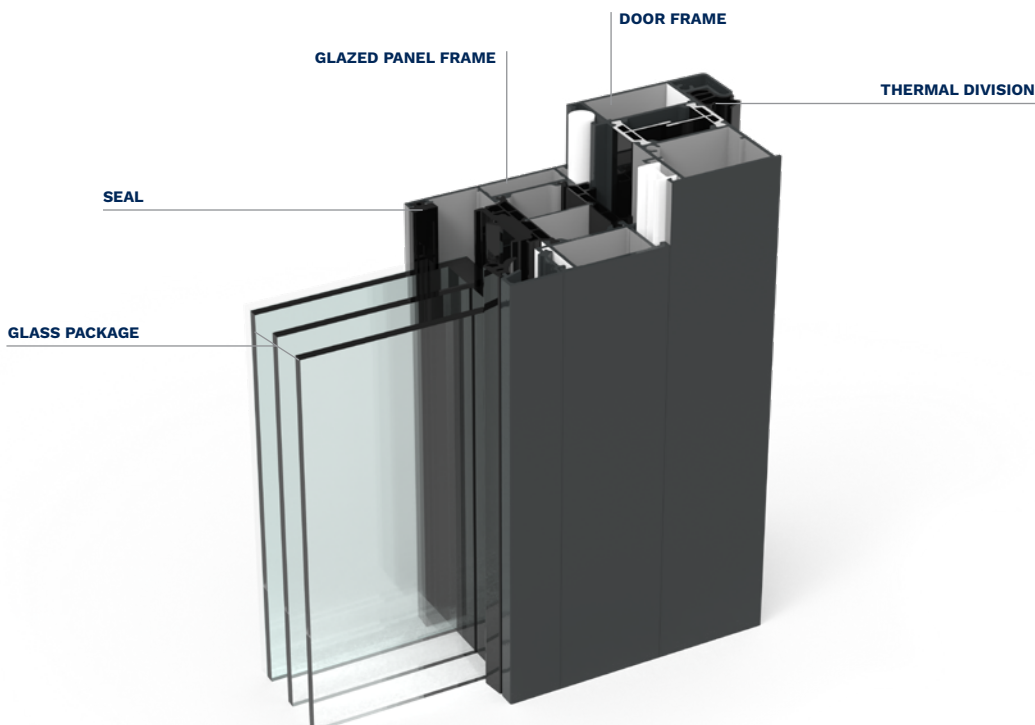
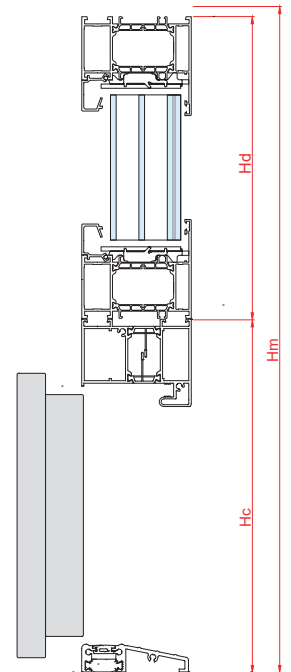
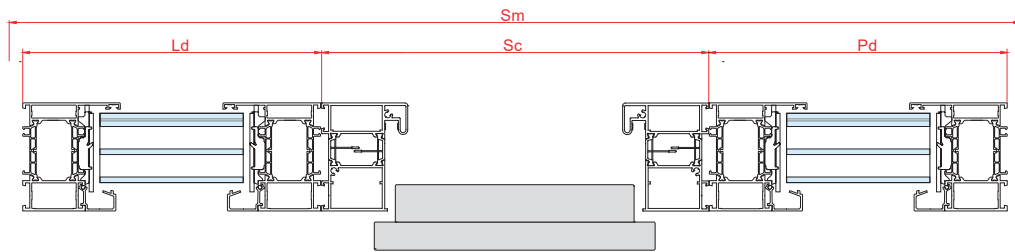

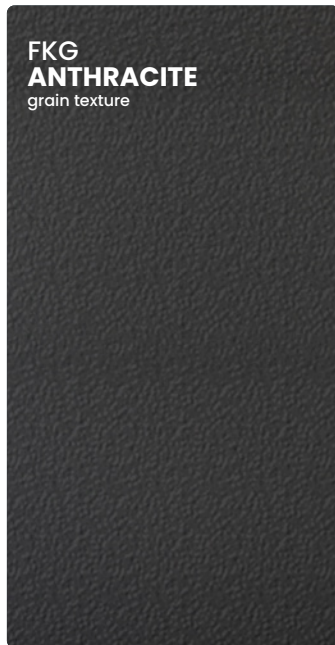
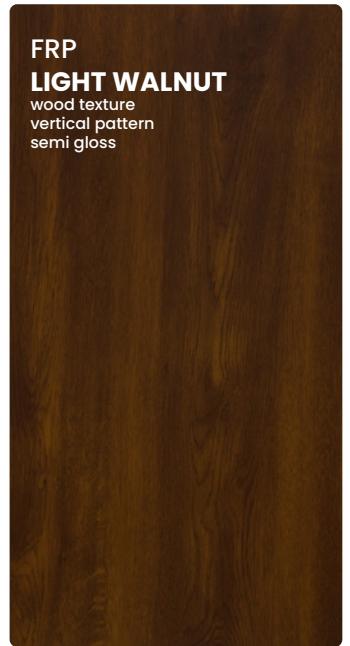
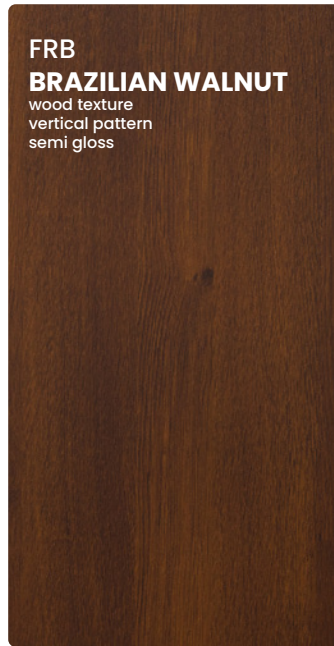
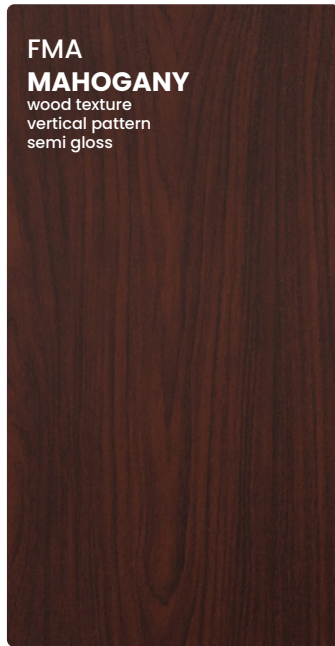
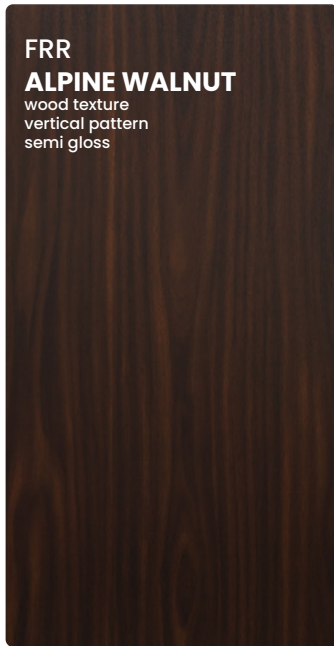

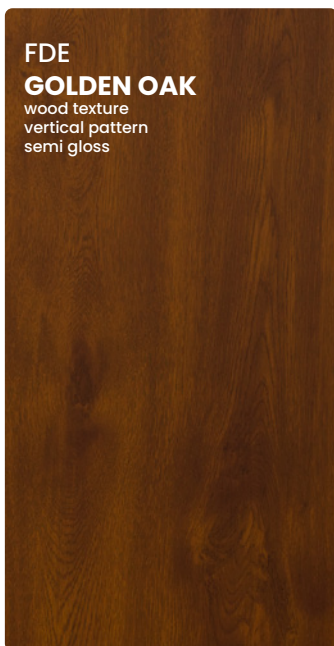

FDE
GOLDEN OAK
wood texture
vertical pattern
semi gloss



FDW
WINCHESTER
wood texture
vertical pattern
semi gloss



FDT
TURNER OAK
wood texture
vertical pattern
matte



FEJ
LIGHT WENGE
wood texture
vertical pattern
semi gloss

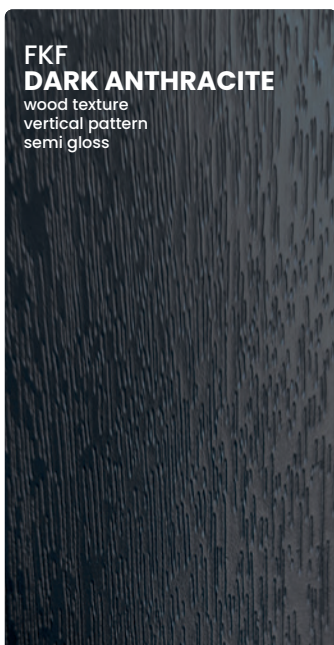

FKF
DARK ANTHRACITE
wood texture
vertical pattern
semi gloss



FKZ
STEEL-GRAY
wood texture
vertical pattern
semi gloss

TWO-COLOURED DOOR*

To obtain a unique configuration of the door to our house, we can combine any two colors from the available TERRA palette. The outer side of the door leaf, as well as the outer frame, will then have a different color than the inner side. In this way, we can even better match the style of the door to the design of the façade and interior. That option is available with an extra charge. Without extra charges, there is also available to order door leaf in a selected color with a frame in a different color.

www.konfigurator.gerda.pl



You are welcome to use the reliable tool that is the Gerda online door configurator. With its help you can intuitively design a door to suit your needs. In addition, you can immediately see the visualization of your dream door.

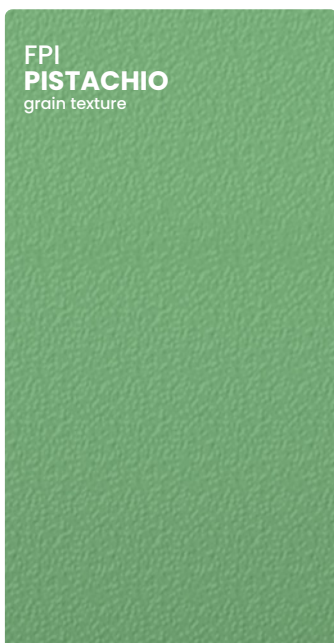

FPI
PISTACHIO
grain texture

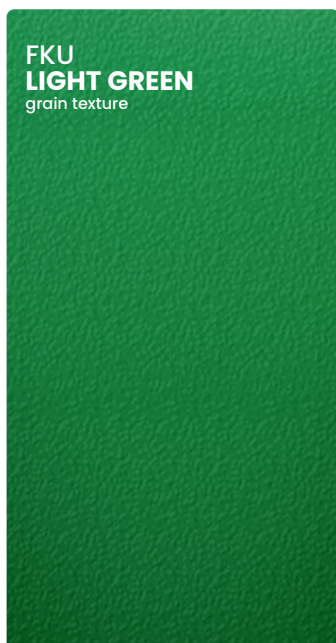

FKU
LIGHT GREEN
grain texture



FKK
DARK GREEN
grain texture



any colour
outer side

any colour
inner side

* EXTRA CHARGE

STANDARD HARDWARE FOR MORTISE LOCKS

STANDARD HARDWARE FOR BOLT LOCKS

HANDLE-HANDLE

PRAGA
HANDLE-HANDLE
LONG ESCUTCHEON

BERGEN
HANDLE-HANDLE
SPLIT ESCUTCHEON
with cylinder protection

TÜRGRIF-FÜRGRIF

PRAGA
HANDLE-HANDLE
LONG ESCUTCHEON
AUXILIARY LOCK
ESCUTCHEON

BERGEN
HANDLE-HANDLE
LONG ESCUTCHEON
with cylinder protection
AUXILIARY LOCK
ESCUTCHEON

CYLINDERS SET, KEYED ALIKE SYSTEM, AB SYSTEM (for doors with mortise locks – single cylinder)	CLASS 5
NUMBER OF KEYS	5 + 2
PRAGA OR BERGEN ESCUTCHEON	to choose from
HINGE CAPS MATCHING FITTING'S COLOUR	✓

EVO – CLASS 5 LOCK CYLINDER



SECURITY CLASS	CLASS 5
MECHANISM DURABILITY	100 000 cycles
NUMBER OF PINS	12 pins: 9 in two rows and 3 side pins
KEY TYPE	horizontal drilled
NUMBER OF KEY CODE COMBINATIONS	9 300 000
RESISTANCE TO BURGLARY CLASS	C
RESISTANCE TO CORROSION CLASS	C
FIRE RESISTANCE	✓
ANTY-DRILLING	two steel hardened nickel-plated anti-drilling pins in the body
EMERGENCY FUNCTION (standard for HANDLE-HANDLE)	✓
NUMBER OF KEYS	5 keys made of 'new silver' (for final user) + 2 brass keys (for installer)
OTHER	code card
WARRANTY	2 years
tedee READY	no

SYSTEM AB



2 x Installer's keys
Installer's key „A“ operates the cylinder until „B“ key is used by final user.



5 x final keys
Use of „B“ key deactivates installer's keys. A sealed opaque bag includes set of „B“ keys and code card.

NOTE! The lock cylinder will reach its final protection level after activation with "B" key.

HARDWARE COLOURS

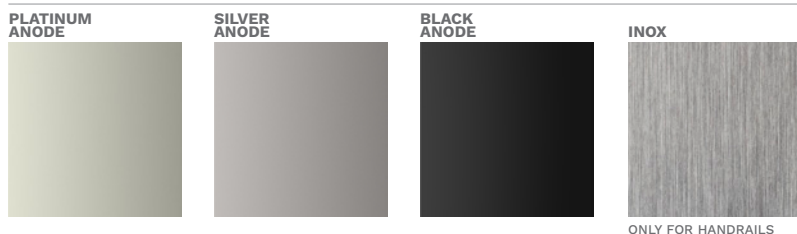

CYLINDER COLOURS

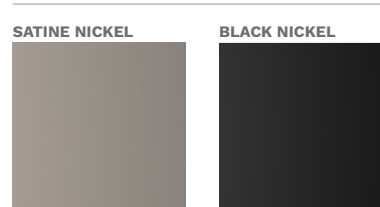

EXTRA CHARGE HARDWARE

<p>HANDLE-HANDLE</p> <p>outside inside</p>	<p>PRAGA</p> <p>LONG ESCUTCHEON with cylinder protection AUXILIARY LOCK ESCUTCHEON with cylinder protection</p>	<p>KNOB-HANDLE</p> <p>outside inside</p>	<p>PRAGA</p> <p>LONG ESCUTCHEON with cylinder protection/ without cylinder protection</p>	<p>BERGEN</p> <p>LONG ESCUTCHEON with cylinder protection</p>	<p>MONTREAL + BERGEN</p> <p>HANDRAIL RING ESCUTCHEON or ESCUTCHEON FOR HANDRAIL with cylinder protection SPLIT ESCUTCHEON</p>	<p>HANDRAIL-HANDLE</p> <p>outside inside</p>	<p>AMSTERDAM + PRAGA</p> <p>HANDRAIL ESCUTCHEON FOR HANDRAIL with cylinder protection/ withOUT cylinder protection LONG ESCUTCHEON</p>
----------------------------------------------	---------------------------------------------------------------------------------------------------------------------	--------------------------------------------	-----------------------------------------------------------------------------------------------	---------------------------------------------------------------	---------------------------------------------------------------------------------------------------------------------------------------	------------------------------------------------	----------------------------------------------------------------------------------------------------------------------------------------------------

THERMO PREMIUM – AUXILIARY LOCK CYLINDER WITH PROTECTION	✓
KNOB-HANDLE SET	✓
6 CLASS LOCK CYLINDERS, KEYED ALIKE SYSTEM	✓
ADJUSTMENT FOR HANDRAIL WITH PUSHBUTTON	✓
HANDRAIL AMSTERDAM / MONTREAL 1800 mm, ELECTRIC STRIKE RECOMMENDED	✓
HANDRAIL AMSTERDAM / MONTREAL 1700 mm, ELECTRIC STRIKE RECOMMENDED	✓
HANDRAIL AMSTERDAM / MONTREAL 1500 mm, ELECTRIC STRIKE RECOMMENDED	✓
HANDRAIL AMSTERDAM / MONTREAL 1000 mm, ELECTRIC STRIKE RECOMMENDED	✓
HANDRAIL AMSTERDAM / MONTREAL 1800 mm WITH PUSHBUTTON AND ADJUSTMENT FOR HANDRAIL AND ELECTRIC STRIKE	✓
HANDRAIL AMSTERDAM / MONTREAL 1700 mm WITH PUSHBUTTON AND ADJUSTMENT FOR HANDRAIL AND ELECTRIC STRIKE	✓
HANDRAIL AMSTERDAM / MONTREAL 1500 mm WITH PUSHBUTTON AND ADJUSTMENT FOR HANDRAIL AND ELECTRIC STRIKE	✓
HANDRAIL AMSTERDAM / MONTREAL 1000 mm WITH PUSHBUTTON AND ADJUSTMENT FOR HANDRAIL AND ELECTRIC STRIKE	✓
HANDRAIL AMSTERDAM 1700 mm WITH WIRELESS PUSHBUTTON AND ELECTRIC STRIKE	✓
HANDRAIL AMSTERDAM 1500 mm WITH WIRELESS PUSHBUTTON AND ELECTRIC STRIKE	✓
HANDRAIL ROSTOCK 2000 mm (ONLY FOR OUTWARD OPENING DOORS)	✓
tedee PRO SET	✓

VITA – CLASS 6 LOCK CYLINDER



SECURITY CLASS	CLASS 6
MECHANISM DURABILITY	100 000 cycles
NUMBER OF PINS	6 active pins
KEY TYPE	vertical incised
NUMBER OF KEY CODE COMBINATIONS	100 000
RESISTANCE TO BURGLARY CLASS	D
RESISTANCE TO CORROSION CLASS	C
FIRE RESISTANCE	✓
ANTY-DRILLING	two steel hardened anti-drilling pins in the body and cylinder
EMERGENCY FUNCTION	standard in key-key version
NUMBER OF KEYS	5 brass nickel-plated keys (for final user) + 2 brass keys (for installer)
OTHER	security card
WARRANTY	5 years (registered product)
tedee READY	✓

HANDRAILS

The visualizations show the door of a standard height of 2076 mm.



THERMO PRIME 75 • THERMO PREMIUM 75

ALUTHERM 75

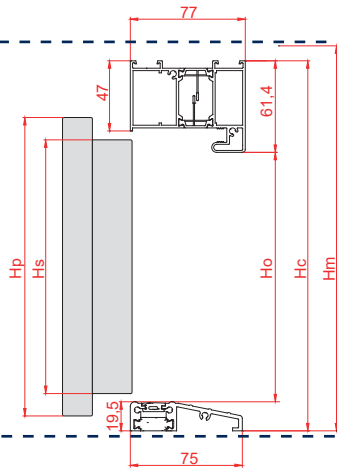

DUOTHERM 75

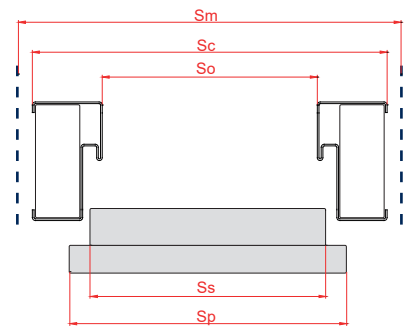
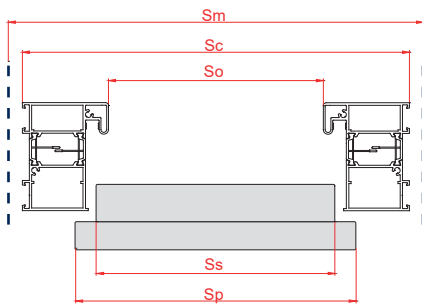
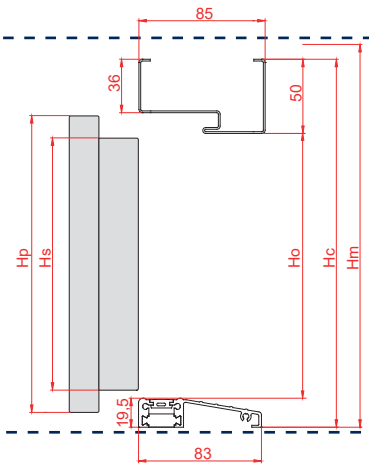

THERMO PREMIUM 60

ALUTHERM 60

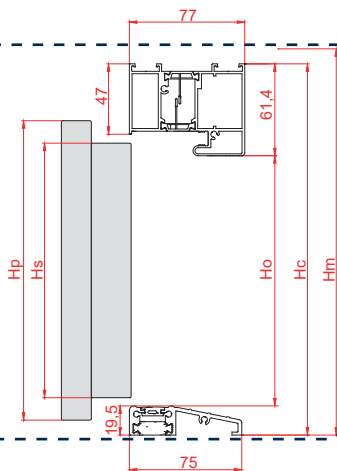

DUOTHERM 60

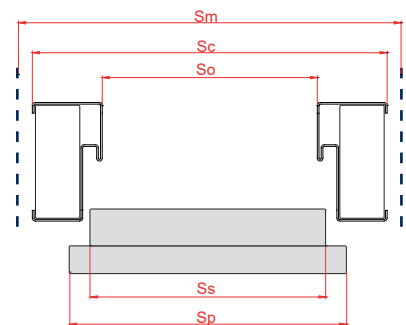
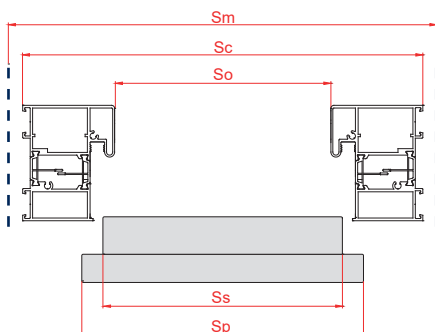
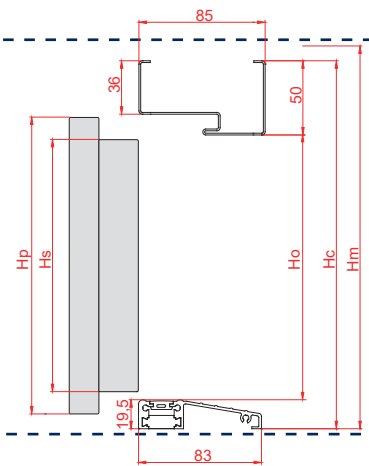

AVOID INSTALLING DARK COLOUR DOORS IN AREAS EXPOSED TO DIRECT AND LONG-TERM SUNLIGHT. DOOR INSTALLED AS EXTERIOR ENTRANCE DOOR AT SITES DIRECTLY EXPOSED TO WEATHER CONDITIONS (RAIN, WIND, ETC.) SHOULD OPEN OUTWARDS. IF MOUNTED AS AN EXTERIOR ENTRANCE DOOR, A ROOFING IS REQUIRED.



THERMO PREMIUM 75 DUO

SIZE	DOOR MODEL	Ss DOOR LEAF WIDTH, NARROW SIDE	Sp DOOR LEAF WIDTH, BROAD SIDE
80	THERMO PREMIUM 75 DUO	812	842
90N		882	912
90E		925	955
100E		1025	1055

HEIGHT	DOOR MODEL	Hs DOOR LEAF HEIGHT, NARROW SIDE	Hp DOOR LEAF HEIGHT, BROAD SIDE
2087	THERMO PREMIUM 75 DUO	2009	2039

SIZE	DOOR FRAME MODEL	So CLEAR OPENING	Sc TOTAL DOOR FRAME WIDTH	Sm RECOMMENDED MOUNTING CUT-OUT WIDTH*	Ho CLEAR HEIGHT OPENING	Hc TOTAL DOOR FRAME HEIGHT	Hm RECOMMENDED MOUNTING CUT- OUT HEIGHT FROM LEVEL 0**
80	ALUTHERM	787	918	938		2087	2097
80+30		1078	1209	1229			
80+40		1178	1309	1329			
80+50		1278	1409	1429			
90 E		900	1031	1051			
90 E +30		1191	1322	1342			
90 E +40		1291	1422	1442			
90 E +50		1391	1522	1542			
100 E		1000	1131	1151			
100 E +30		1291	1422	1442			
100 E +40		1391	1522	1542			
100 E +50		1491	1622	1642			

* INCLUDES MOUNTING CLEARANCE OF 10 mm PER SIDE

** INCLUDES MOUNTING CLEARANCE OF 10 mm

THERMO PREMIUM 75 DUO

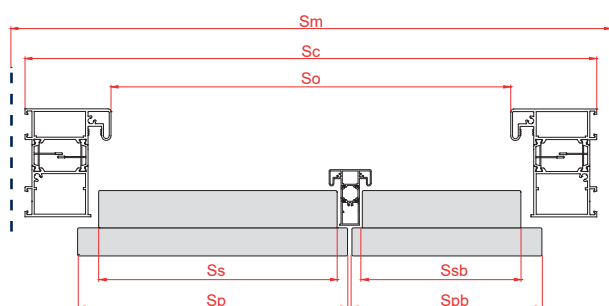
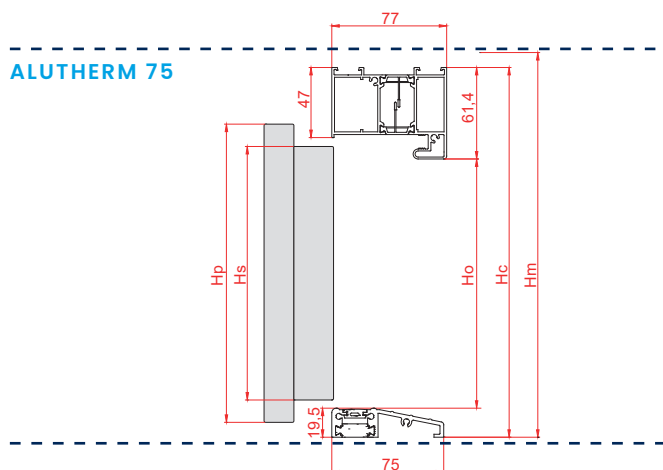

AVOID INSTALLING DARK COLOUR DOORS IN AREAS EXPOSED TO DIRECT AND LONG-TERM SUNLIGHT. DOOR INSTALLED AS EXTERIOR ENTRANCE DOOR AT SITES DIRECTLY EXPOSED TO WEATHER CONDITIONS (RAIN, WIND, ETC.) SHOULD OPEN OUTWARDS. IF MOUNTED AS AN EXTERIOR ENTRANCE DOOR, A ROOFING IS REQUIRED.



Gerda Sp. z o.o.

Sokołów, ul. Sokołowska 49
05-806 Komorów
POLAND

This catalogue does not constitute an offer under the provisions of law and is merely informational.
Gerda Sp. z o.o., committed to continuously improving its products and services, reserves the right (without prior notice) to introduce changes to products that, due to the printing material preparation process, may not be included in this material.
Despite all the effort and care in controlling the presented content, substantial or printing errors may occur.
Colours presented herein may differ from the original due to different colour reproduction technique in the printing process. The owner of the copyright for this catalogue, as well as Gerda Sp. z o.o. logotypes and graphics, is Gerda Sp. z o.o.
It is prohibited to copy or distribute any content and material without the prior consent of Gerda Sp. z o.o.

Distributor:



ENTRY DOORS TORONTO INC.

Quality is not an act, it is a habit!

ENTRY DOORS TORONTO INC.

7321 Victoria Park Ave. unit 20
L3R2Z8 Markham, Ontario Canada
office phone: 416-800-7737, direct line: 647-800-1627 (Alex Sel)
<https://www.entrydoors-toronto.com/>
e-mail: info@entrydoors-toronto.com

38 YEARS
GERDA®